

Dia 22mm length 36mm Planetary Gearbox+motor



JPM-2236B

Weight:N/A

Typical Application

Audio and visual products, high-end toys, personal health care products and security equipment

Tags: Planetary Gearbox motor

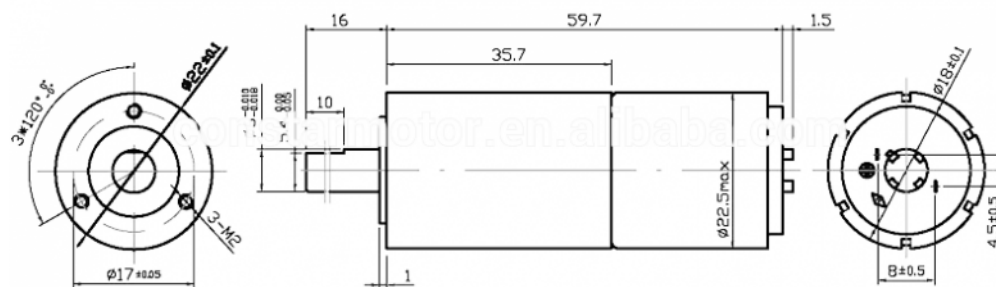

Series	Dimension (mm)	Voltage (V)	No-load Speed (rpm)	No-load Current (mA)	Load Torque (mNm)	Load Speed (rpm)	Load Current (mA)	Max Torque (mNm)	Reduction Ratio
JPM-2236B	$\phi 22 \times 60.0$	12	120	45	200	90	500	850	1/66

Customization

Lead wires length, shaft length, special coils, gearheads, Encoder

Dia 12mm length 15mm Planetary Gearbox motor

JPM-1215B1230

Weight:N/A



Typical Application

Audio and visual products, high-end toys, personal health care products and security equipment

Tags: Planetary Gearbox motor

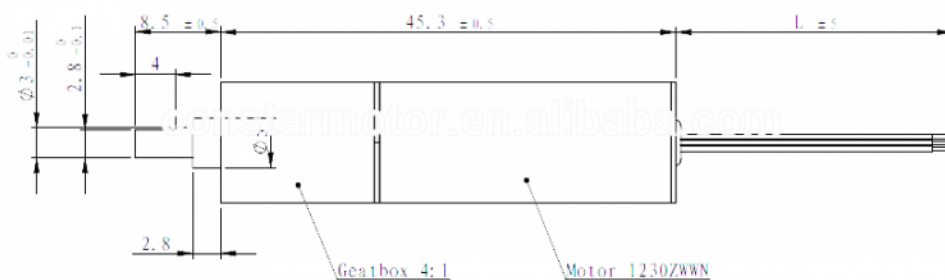

Item/项目	Voltage/电压	No-load speed/空载转速	No-load current/空载电流	Terminal resistance/端电阻	Load torque/额定负载	Load speed/负载转速	Load current/负载电流	Reduction ratio/减速比	Max Rated torque/最大额定容许扭力	Max momentary tolerance torque/最大瞬间容许扭力
UNIT/单位	V	RPM	mA	Ω	mNm	RPM	mA		mNm	mNm
Date/数值	12.0	5980 \pm 15%	300 Max	2.63	30	3350 \pm 15%	2100 \pm 20%	4: 1	80	240

Customization

Lead wires length, shaft length, special coils, gearheads.

Audio and visual products, high-end toys, personal health care products and security equipment



JPM-1208HRC1230

Weight:N/A

Typical Application

Audio and visual products, high-end toys, personal health care products and security equipment

Tags: Planetary Gearbox motor

UNIT:MM

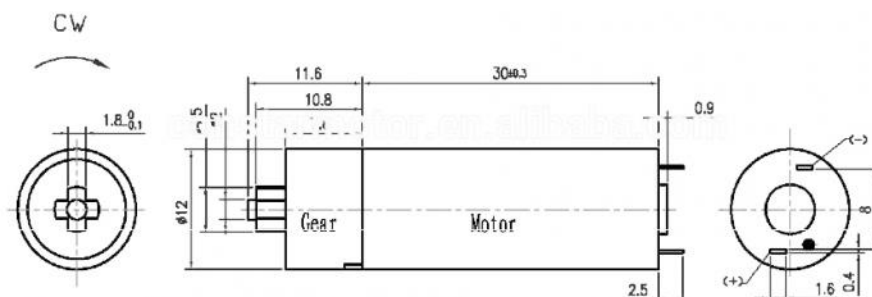

Standard Size Series	Voltage (V)	Terminal resistance (Ω)	No-load Speed (rpm)	No-load Current (mA)	Load Torque (mNm)	Load Speed (rpm)	Load Current (mA)	Max Torque (mNm)	Reduction ratio
JPM-1208HRC1230	5	7.5	86	70	19.6	75	160	137.2	1/120

Customization

Lead wires length, shaft length, special coils, gearheads.

Curve

GH1208RC-1230R004-5.0

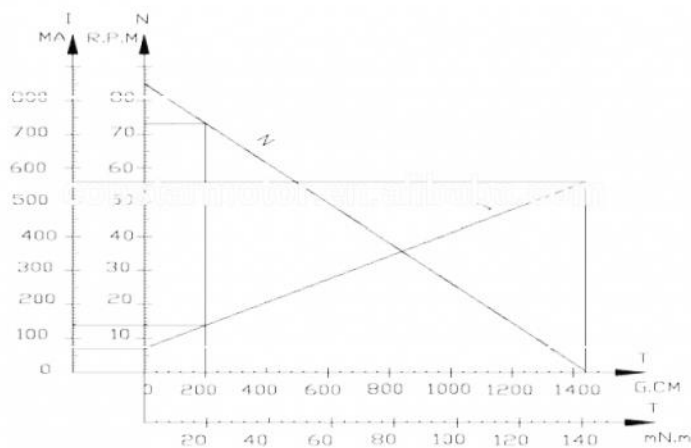

Dia 12mm Plastic Planetary Gearbox motor

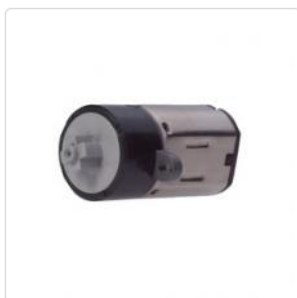

JPM-1208H

Weight:N/A

Typical Application

Audio and visual products, high-end toys, personal health care products and security equipment

Tags: Planetary Gearbox motor

Standard Size Series	Voltage (V)	Terminal resistance (Ω)	No-load Speed (rpm)	No-load Current (mA)	Load Torque (mNm)	Load Speed (rpm)	Load Current (mA)	Max Torque (mNm)	Reduction ratio
JPM-1208H 050-2.5	2.5	3.5	95	60	14.7	75	180	68.6	1/120
JPM-1208H 1220-3.0	3	4	105	100	19.6	73	260	76.4	1/120
JPM-1208H 051-5.0	5	17.8	88	35	14.7	66	100	62.7	1/120

Customization

Lead wires length, shaft length, special coils, gearheads

Dia 10mm plastic Planetary Gearbox motor



JPM-1007H

Weight:N/A

Typical Application

Audio and visual products, high-end toys, personal health care products and security

Key Features

Motor with Plastic Planetary gear box,

High torque

Low noise

Low speed

Tags: Planetary Gearbox motor

Standard Size Series	Voltage (V)	Terminal resistance (Ω)	No-load Speed (rpm)	No-load Current (mA)	Load Torque (mNm)	Load Speed (rpm)	Load Current (mA)	Max Torque (mNm)	Reduction ratio
JPM-1007H1012	2.5	3.7	110	100	9.8	80	230	37.2	1/171

Customization

Lead wires length, shaft length, special coils, gearheads

Dia 8mm Planetary Gearbox motor

JPM-0812B

Weight:N/A



Typical Application

Audio and visual products, high-end toys, personal health care products and security equipment

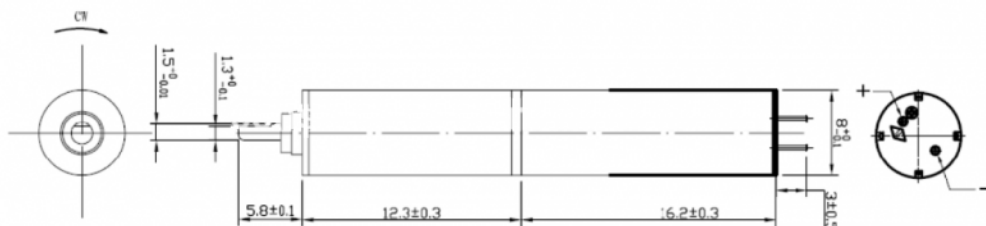
Tags: Planetary Gearbox motor

Series	Dimension (mm)	Voltage (V)	No-load Speed (rpm)	No-load Current (mA)	Load Torque (mNm)	Load Speed (rpm)	Load Current (mA)	Max Torque (mNm)	Reduction Ratio
JPM-0812B0816	φ8*28.5	8	930	15	2.94	670	40	11.8	1/16

Customization

Lead wires length, shaft length, special coils, gearheads.

Dia 6mm Planetary Gearbox motor

JPM-0607H

Weight:N/A



Typical Application

Audio and visual products, high-end toys, personal health care products and security equipment

Tags: Planetary Gearbox motor

Standard Size Series	Voltage (V)	Terminal resistance (Ω)	No-load Speed (rpm)	No-load Current (mA)	Load Torque (mNm)	Load Speed (rpm)	Load Current (mA)	Max Torque (mNm)	Reduction ratio
JPM-0607H	3	13.7	1240	54	0.19	1164	54	3.2	1/25

Customization

Lead wires length, shaft length, special coils, gearheads

Dia 70mm metal planetary gear JPM70



JPM70

Weight: N/A (approx.)

Tags: Planetary Gearbox motor

DIRECTION OF ROTATION

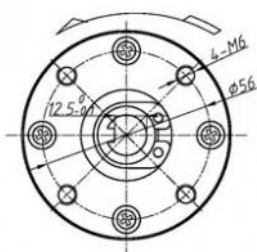

T JX70RZZ

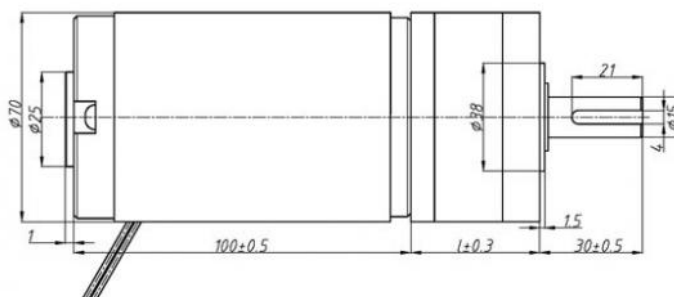
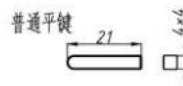

额定电压 Rated Voltage	减速比 Reduction Ratio	1/3.7	1/5.2	1/13.7	1/19.2	1/27	1/51	1/71	1/100	1/139	1/187	1/262	1/368	1/514	1/720
	齿轮箱长度L(mm) Gearbox Length	38.8		52			67.2				80.5				
12V	额定力矩(kg.cm) Rated Torque	5.5	7.7	18.4	25.7	36.2	60.9	84.7	119	166	203	284	399	557	600
	额定转速(rpm) Rated Speed	919	654	248	177	126	66.7	47.9	34.0	24.5	18.2	13.0	9.2	6.6	4.7
	堵转力矩(kg.cm) Stall Torque	19.0	26.7	63.3	88.8	125	210	292	412	572	699	979	/	/	/
24V	额定力矩(kg.cm) Rated Torque	8.6	12.0	28.6	40.0	56.3	94.7	132	186	258	315	441	600	600	600
	额定转速(rpm) Rated Speed	657	468	177	127	90	48	34	24	17.5	13.0	9.3	6.6	4.7	3.4
	堵转力矩(kg.cm) Stall Torque	32.1	45.1	107	150	211	355	494	695	966	1180	/	/	/	/

Dia 60mm metal planetary gear JPM60



JPM60

Weight: N/A (approx.)

Tags: Planetary Gearbox motor

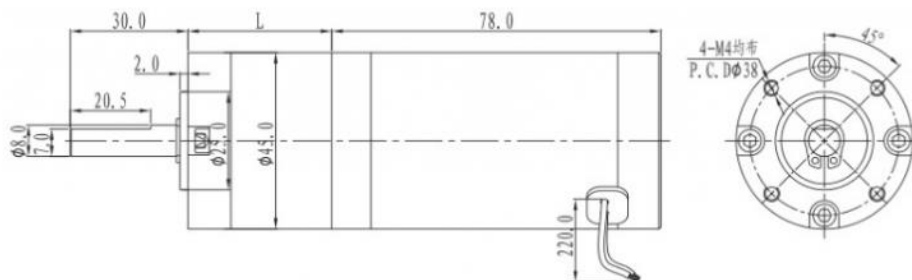

电压 Voltage(VDC)	12V	12V	12V	12V	12V	24V	24V	24V	24V	24V
马达型号 Motor Model	40GG	40GG	40GG	40GG	40GG	40GG	40GG	40GG	40GG	40GG
减速比 Reduction Ratio	1/972	1/675	1/562	1/162	1/36	1/972	1/675	1/562	1/162	1/36
齿轮箱长度 Gearbox Length(mm)	66.7	66.7	66.7	56.7	46.7	66.7	66.7	66.7	56.7	46.7
空载转速 No-Load Speed(Rpm)	4	6	7	20	110	4	6	7	20	66
额定转速 Rated Speed(Rpm)	2.8	4.2	4.9	14	77	2.8	4.2	4.9	14	46.2
额定力矩 Rated Torque(Kg.cm)	35	35	35	20	5	35	35	35	22	10.9
额定电流 Rated Current(Amp)	2.2	2.2	2.2	2.2	2.2	1.5	1.5	1.5	1.5	0.55

Dia 57mm metal planetary gear JPM57-C



JPM57-C

Weight: N/A (approx.)

Tags: Planetary Gearbox motor

DIRECTION OF ROTATION

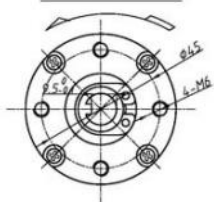

TJX57RWA

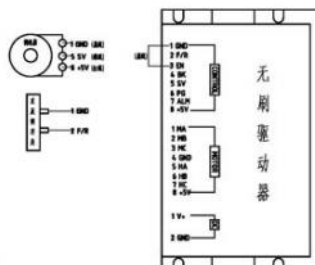
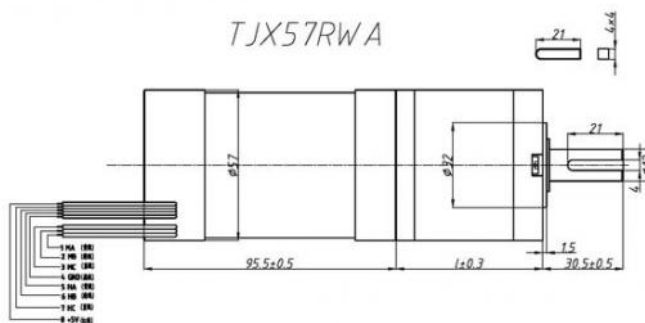

额定电压 Rated Voltage	减速比 Reduction Ratio	1/3.7	1/5.2	1/13.7	1/19.2	1/27	1/51	1/71	1/100	1/139	1/187	1/262	1/368	1/514	1/720
	齿轮箱长度L(mm) Gearbox Length	40.3		55.5			66.7			82					
24V	额定力矩(kg.cm) Rated Torque	6.1	8.6	20	29	40	68	94	133	184	225	315	443	500	500
	额定转速(rpm) Rated Speed	865	615	234	167	119	63	45	32.0	23.0	17.1	12.2	8.7	6.2	4.4
	堵转力矩(kg.cm) Stall Torque	27.5	38.7	92	129	181	304	424	597	829	1013	/	/	/	/

Dia 57mm metal planetary gear JPM57



JPM57

Weight: N/A (approx.)

Tags: Planetary Gearbox motor

Appearance Size

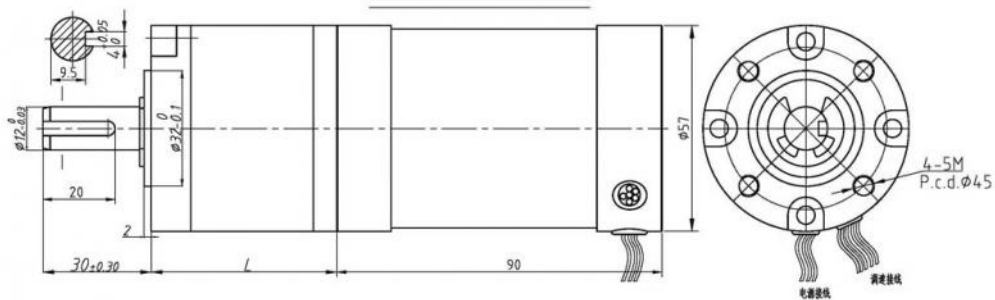

特征点	电压	电流	输入功率	转矩	转速	输出功率	效率	时间
	V	A	W	N.m	rpm	W	%	S
不加载点(No Load)	24.16	1.218	29.43	0.027	376.5	1.064	3.6	33.19
最高效率点(Eff_max)	24.09	5.537	133.4	2.450	316.8	81.26	60.9	190.9
最大输出功率点(Pout_max)	24.09	5.661	136.4	2.512	315.1	82.87	60.8	194.1
最大转矩点(Torque_max)	24.09	5.661	136.4	2.512	315.1	82.87	60.8	194.1
结束点(End)	24.09	5.661	136.4	2.512	315.1	82.87	60.8	194.1

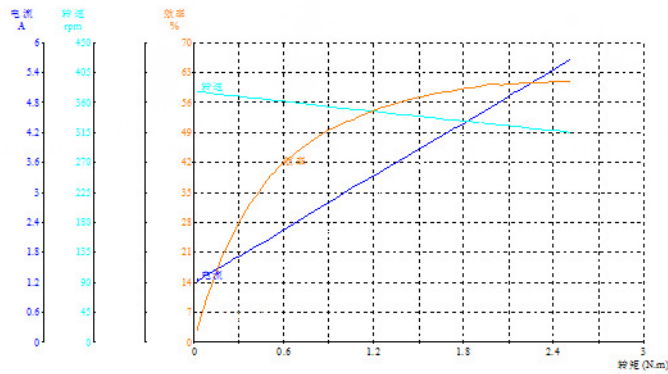

Dia 50mm metal planetary gear JPM50



JPM50

Weight: N/A (approx.)

Tags: Planetary Gearbox motor

Appearance size

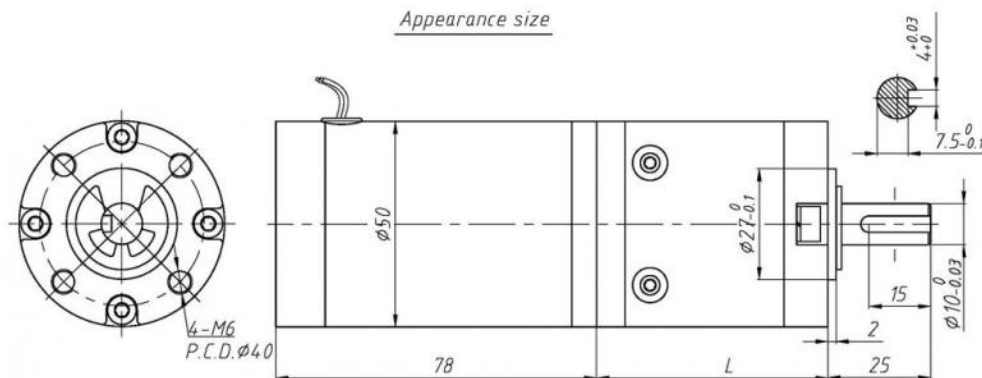

Dia 45mm planetary gear

JPM45

Tags: planetary gear

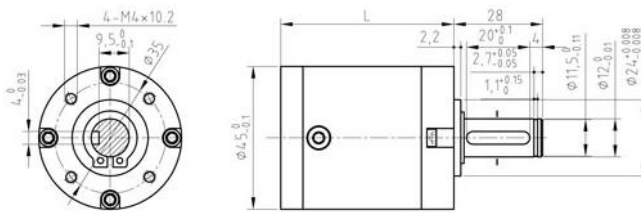

外壳材料 Housing material	金属 steel
齿轮材料 Gearwheel material	金属 steel ①
输出轴承型式 Bearing at output	滚动轴承 Ball bearings
径向负载 Radial load (10mm from flange)	≤20 Kgf
轴向负载 shaft axial load	≤10 Kgf
径向间隙 Radial play of shaft	≤0.04mm
轴向间隙 Thrust play of shaft	≤0.4mm
背隙(无负载时) Backlash, at no-load	≤2°
连续运行时最高允许输入转速 Max permissible input speed at continuous working	≤30000rpm ②
工作温度范围 Operating temperature range	-30~100°C

● 标准减速比型式 Gearboxes Specifications

减速比(部分) Reduction ratio (part)	额定允许负载 rated tolerance torque	瞬间允许负载 Max momentary tolerance torque	效率 Efficiency	L (mm)
4.3, 5.1, 6.3, 7.6	65Kgf-cm	195Kgf-cm	93%	43.8
14.7, 16.3, 17.3, 18.6, 19.2, 21.9 23.9, 25.8, 27.2, 28.9, 32, 32.9 38.7, 39.7, 48, 58.1	86Kgf-cm	258Kgf-cm	86%	54.6
65.6, 74.6, 81.4, 90.5, 92.6, 98.5 109, 112.1, 117.2, 124.6, 132, 138 141.8, 146.7, 150.4, 162.4, 166.9 171.2, 182, 196.5, 201.5, 207.1 220.3, 243.9, 250.7	108Kgf-cm	324Kgf-cm	80%	65.4
277.4, 295.2, 302.6, 315.8, 335.8 342.8, 351, 366.2, 373.3, 382.2 399.4, 413.2, 424.8, 450, 459.3 472.2, 483.4, 500.1, 512.7, 537.4 555.9, 569.1, 583.5, 611.5, 620.6 632.6, 648, 670, 686.9, 706.2 719.9, 744.7, 751.1, 763.6, 785 824.4, 831.4, 847.6, 854.7, 869 893.4, 924.2, 950.1, 997.8, 1006 1023, 1052, 1078, 1081, 1119, 1147 1238, 1269, 1272, 1305, 1388, 1499 1536, 1580, 1680, 1860, 1907, 2251 2307, 2793, 3380	130Kgf-cm	390Kgf-cm	75%	76.2

表中*指速比数值。 * Reduction ratio

①——根据受力,行星轮可选用塑料。 Planet gears can be plastic according to torque.

②——高转速时齿轮箱长度非标。 Gearbox length is nonstandard at high speed.

Dia 42mm planetary gear.

JPM42

Tags: Planetary Gearbox motor

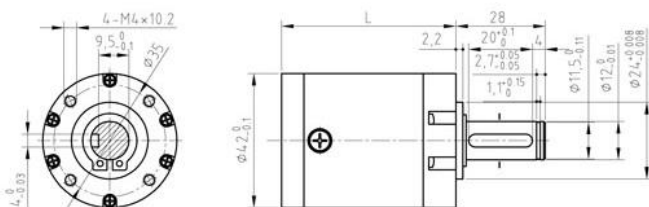

外壳材料 Housing material	金属 steel
齿轮材料 Gearwheel material	金属 steel ①
输出轴承型式 Bearing at output	滚动轴承 Ball bearings
径向负载 Radial load (10mm from flange)	≤20 Kgf
轴向负载 shaft axial load	≤10 Kgf
径向间隙 Radial play of shaft	≤0.04mm
轴向间隙 Thrust play of shaft	≤0.4mm
背隙(无负载时) Backlash,at no-load	≤2°
连续运行时最高允许输入转速 Max permissible input speed at continuous working	≤30000rpm ②
工作温度范围 Operating temperature range	-30~100°C

● 标准减速比型式 Gearboxes Specifications

减速比(部分) Reduction ratio (part)	额定允许负载 rated tolerance torque	瞬间允许负载 Max momentary tolerance torque	效率 Efficiency	L (mm)
4.3, 5.1, 6.3, 7.6	65Kgf-cm	195Kgf-cm	93%	43.8
14.7, 16.3, 17.3, 18.6, 19.2, 21.9 23.9, 25.8, 27.2, 28.9, 32, 32.9 38.7, 39.7, 48, 58.1	86Kgf-cm	258Kgf-cm	86%	54.6
65.6, 74.6, 81.4, 90.5, 92.6, 98.5 109, 112.1, 117.2, 124.6, 132, 138 141.8, 146.7, 150.4, 162.4, 166.9 171.2, 182, 196.5, 201.5, 207.1 220.3, 243.9, 250.7	108Kgf-cm	324Kgf-cm	80%	65.4
277.4, 295.2, 302.6, 315.8, 335.8 342.8, 351, 366.2, 373.3, 382.2 399.4, 413.2, 424.8, 450, 459.3 472.2, 483.4, 500.1, 512.7, 537.4 555.9, 569.1, 583.5, 611.5, 620.6 632.6, 648, 670, 686.9, 706.2 719.9, 744.7, 751.1, 763.6, 785 824.4, 831.4, 847.6, 854.7, 869 893.4, 924.2, 950.1, 997.8, 1006 1023, 1052, 1078, 1081, 1119, 1147 1238, 1269, 1272, 1305, 1388, 1499 1536, 1580, 1680, 1860, 1907, 2251 2307, 2793, 3380	130Kgf-cm	390Kgf-cm	75%	76.2

表中*指速比数值。 * - Reduction ratio

①——根据受力,行星轮可选用塑料。 Planet gears can be plastic according to torque.

②——高转速时齿轮箱长度非标。 Gearbox length is nonstandard at high speed.

Dia 38mm metal planetary gear JPM38-2

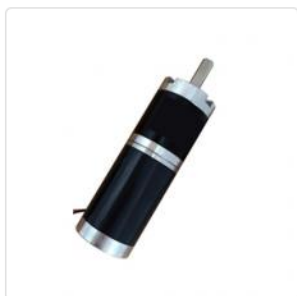

JPM38-2

Weight: N/A (approx.)

Tags: Planetary Gearbox motor

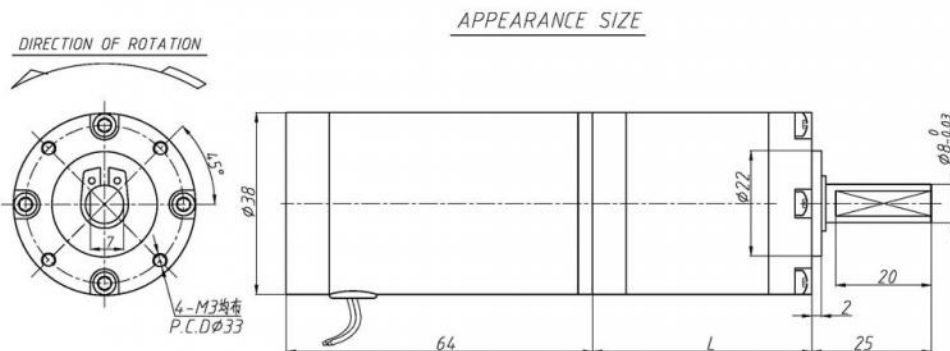

额定电压 Rated Voltage	减速比 Reduction Ratio	1/3.7	1/5.2	1/13.7	1/19.2	1/27	1/51	1/71	1/100	1/139	1/187	1/262	1/368	1/514	1/720	1/970	1/1900
	齿轮箱长度L(mm) Gearbox Length	28.2		37			46			54.8			64				
12V	额定力矩 (kg.cm) Rated Torque	0.6	0.8	1.9	2.7	3.8	6.5	9.1	12.8	17.7	21.0	29.5	41.4	57.8	81.0	99.4	100.0
	额定转速 (rpm) Rated Speed	869	618.6	234.7	167.5	119.1	63.1	45.3	32.2	23.1	17.2	12.3	8.7	6.3	4.5	3.3	1.7
	堵转力矩 (kg.cm) Stall Torque	2.0	2.8	6.8	9.6	13.5	23.2	32.3	45.5	63.3	75.1	105.2	147.8	206.4	300.0	300.0	300.0
24V	额定力矩 (kg.cm) Rated Torque	0.8	1.1	2.7	3.8	5.3	9.1	12.7	17.9	24.8	29.5	41.3	58.0	81.0	113.4	139.2	100.0
	额定转速 (rpm) Rated Speed	1027	730.8	277.4	197.9	140.7	74.5	53.5	38.0	27.3	20.3	14.5	10.3	7.4	5.3	3.9	2.0
	堵转力矩 (kg.cm) Stall Torque	2.9	4.1	10.1	14.1	19.8	34.1	47.5	66.9	93.0	110.4	151.7	217.4	303.6	300.0	300.0	300.0

Dia 38mm metal planetary gear JPM38-1



JPM38-1

Weight: N/A (approx.)

Tags: Planetary Gearbox motor

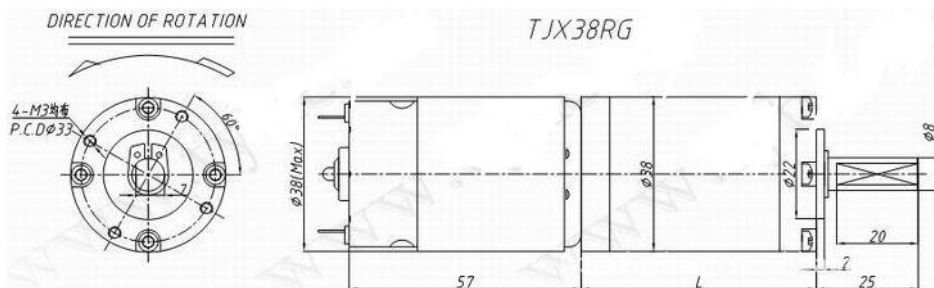

额定电压 Rated Voltage	减速比 Reduction Ratio	Gearbox Length (mm)															
		1/3.7	1/5.2	1/13.7	1/19.2	1/27	1/51	1/71	1/100	1/139	1/187	1/262	1/369	1/514	1/720	1/970	1/1900
	内齿轮长度L(mm) Gearbox Length	28.2			37			46			54.8			61			
12V	额定转矩(kg.cm) Rated Torque	0.4	0.6	1.4	2.0	2.8	4.8	6.6	8.4	13.0	15.4	21.6	30.4	42.1	59.5	73.0	109.0
	额定转速(rpm) Rated Speed	809	582.7	221.2	157.9	112.2	59.4	42.7	30.3	21.8	16.2	11.6	8.2	5.9	4.2	3.1	1.6
	堵转转矩(kg.cm) Stall Torque	2.3	3.3	8.0	11.2	15.8	27.1	37.8	53.2	73.9	87.8	123.0	172.7	241.3	300.0	300.0	300.0
24V	额定转矩(kg.cm) Rated Torque	0.5	0.8	2.0	2.4	3.4	6.5	9.0	9.5	13.2	17.8	24.9	35.0	48.9	68.5	92.3	100.0
	额定转速(rpm) Rated Speed	1116	815.1	309.5	220.8	157.0	83.1	59.7	42.4	30.5	22.7	16.2	11.5	8.2	5.9	4.1	2.2
	堵转转矩(kg.cm) Stall Torque	3.2	4.6	12.0	14.4	20.3	38.3	53.3	56.3	78.3	105.3	147.6	207.3	289.5	300.0	300.0	300.0

Dia 36mm metal planetary gear JPM36-2



JPM36-2

Weight: N/A (approx.)

Tags: Planetary Gearbox motor

Appearance size

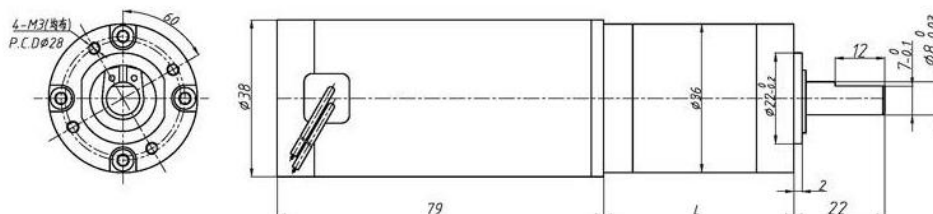

外壳材料 Housing material	金属 steel
齿轮材料 Gearwheel material	金属 steel ①
输出轴承型式 Bearing at output	滚动轴承 Ball bearings
径向负载 Radial load (10mm from flange)	≤10 Kgf
轴向负载 shaft axial load	≤6.0 Kgf
径向间隙 Radial play of shaft	≤0.04mm
轴向间隙 Thrust play of shaft	≤0.4mm
背隙 (无负载时) Backlash, at no-load	≤2°
连续运行时最高允许输入转速 Max permissible input speed at continuous working	≤3000rpm ②
工作温度范围 Operating temperature range	-30~100°C

减速比 (部分) Reduction ratio (part)	额定允许负载 rated tolerance torque	瞬间允许负载 Max momentary tolerance torque	效率 Efficiency	L (mm)
4.3, 5.1, 6.3, 7.6	32.4Kgf-cm	97.2Kgf-cm	93%	35.6
14.7, 16.3, 17.3, 18.6, 19.2, 21.9 23.9, 25.8, 27.2, 28.9, 32, 32.9 38.7, 39.7, 4.8, 58.1	43.2Kgf-cm	129.6Kgf-cm	86%	44.2
65.6, 74.6, 81.4, 90.5, 92.6, 98.5 109, 112.1, 117.2, 124.6, 132, 138 141.8, 146.7, 150.4, 162.4, 166.9 171.2, 182, 196.5, 201.5, 207.1 220.3, 243.9, 250.7	54.0Kgf-cm	162Kgf-cm	80%	52.8
277.4, 295.2, 302.6, 315.8, 335.8 342.8, 351, 366.2, 373.3, 382.2 399.4, 413.2, 424.8, 450, 459.3 472.2, 483.4, 500.1, 512.7, 537.4 555.9, 569.1, 583.5, 611.5, 620.6 632.6, 648, 670, 686.9, 706.2 719.9, 744.7, 751.1, 763.6, 785 824.4, 831.4, 847.6, 854.7, 869 893.4, 924.2, 950.1, 997.8, 1006 1023, 1052, 1078, 1081, 1119, 114.7 1238, 1269, 1272, 1305, 1388, 1499 1536, 1580, 1680, 1860, 1907, 2251 2307, 2793, 3380	64.8Kgf-cm	194.4Kgf-cm	75%	61.4

表中*指速比数值。 * Reduction ratio

①——根据受力,行星轮可选用塑料。 Planet gears can be plastic according to torque.

②——高转速时齿轮箱长度非标。 Gearbox length is nonstandard at high speed.

Dia 36mm metal planetary gear JPM36-1



JPM36-1

Weight: N/A (approx.)

Tags: planetary gear

APPEARANCE SIZE

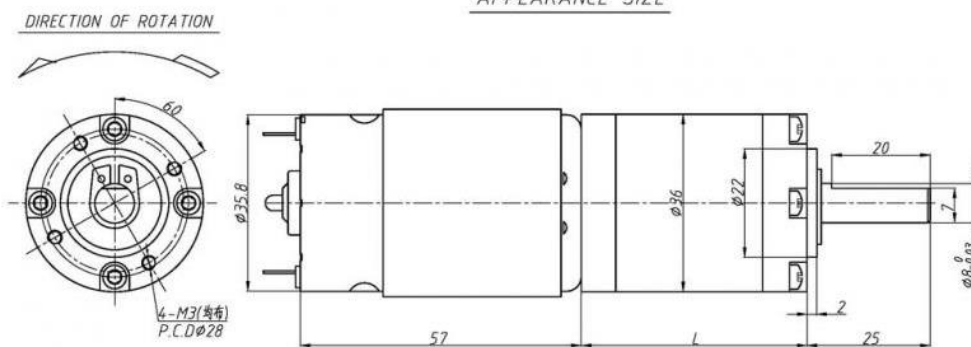

外壳材料 Housing material	金属 steel
齿轮材料 Gearwheel material	金属 steel ①
输出轴承型式 Bearing at output	滚动轴承 Ball bearings
径向负载 Radial load (10mm from flange)	≤10 Kgf
轴向负载 shaft axial load	≤6.0 Kgf
径向间隙 Radial play of shaft	≤0.04mm
轴向间隙 Thrust play of shaft	≤0.4mm
背隙 (无负载时) Backlash, at no-load	≤2°
连续运行时最高允许输入转速 Max permissible input speed at continuous working	≤30000rpm ②
工作温度范围 Operating temperature range	-30~100°C

减速比 (部分) Reduction ratio (part)	额定允许负载 rated tolerance torque	瞬间允许负载 Max momentary tolerance torque	效率 Efficiency	L (mm)
4.3, 5.1, 6.3, 7.6	32.4Kgf-cm	97.2Kgf-cm	93%	35.6
14.7, 16.3, 17.3, 18.6, 19.2, 21.9 23.9, 25.8, 27.2, 28.9, 32, 32.9 38.7, 39.7, 48, 58.1	43.2Kgf-cm	129.6Kgf-cm	86%	44.2
65.6, 74.6, 81.4, 90.5, 92.6, 98.5 109, 112.1, 117.2, 124.6, 132, 138 141.8, 146.7, 150.4, 162.4, 166.9 171.2, 182, 196.5, 201.5, 207.1 220.3, 243.9, 250.7	54.0Kgf-cm	162Kgf-cm	80%	52.8
277.4, 295.2, 302.6, 315.8, 335.8 342.8, 351, 366.2, 373.3, 382.2 399.4, 413.2, 424.8, 450, 459.3 472.2, 483.4, 500.1, 512.7, 537.4 555.9, 569.1, 583.5, 611.5, 620.6 632.6, 648, 670, 686.9, 706.2 719.9, 744.7, 751.1, 763.6, 785 824.4, 831.4, 847.6, 854.7, 869 893.4, 924.2, 950.1, 997.8, 1006 1023, 1052, 1078, 1081, 1119, 1147 1238, 1269, 1272, 1305, 1388, 1499 1536, 1580, 1680, 1860, 1907, 2251 2307, 2793, 3380	64.8Kgf-cm	194.4Kgf-cm	75%	61.4

表中*指速比数值。 * Reduction ratio

①——根据受力，行星轮可选用塑料。 Planet gears can be plastic according to torque.

②——高转速时齿轮箱长度非标。 Gearbox length is nonstandard at high speed.

Dia 32mm metal planetary gear JPM32



JPM32

Weight: N/A (approx.)

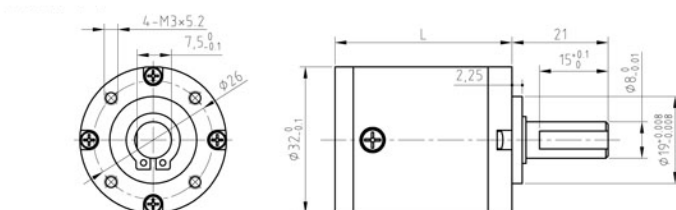
Tags: Planetary Gearbox motor

外壳材料 Housing material	金属 steel
齿轮材料 Gearheel material	金属 steel ①
输出轴承型式 Bearing at output	滚动轴承 Ball bearings
径向负载 Radial load (10mm from flange)	≤10 Kgf
轴向负载 shaft axial load	≤6.0 Kgf
径向间隙 Radial play of shaft	≤0.04mm
轴向间隙 Thrust play of shaft	≤0.4mm
背隙(无负载时) Backlash,at no-load	≤2°
连续运行时最高允许输入转速 Max permissible input speed at continuous working	≤3600rpm ②
工作温度范围 Operating temperature range	-30~100°C

减速比(部分) Reduction ratio (part)	额定允许负载 rated tolerance torque	瞬间允许负载 Max momentary tolerance torque	效率 Efficiency	L (mm)
4.4, 5.25, 6.7, 8.3	23.4Kgf-cm	70.2Kgf-cm	93%	31.2
15.1, 16.9, 18, 19.4, 20.1, 23.1 25.6, 27.6, 29.3, 31.8, 35 36.5, 43.5, 55.2	31.0Kgf-cm	93.0Kgf-cm	86%	38.7
61.7, 68.7, 77.1, 87.6, 100.6, 109 120, 125, 129, 134.1, 139.8, 144.7 149.1, 154, 160.4, 166.8, 183.8 191.4, 211.7, 228.4, 233.3, 243 264.5, 290, 296.3	38.8Kgf-cm	116.4Kgf-cm	80%	46.2
335.9, 344.8, 368.2, 373.4 375.5, 385.5, 411.4, 417.4 428.5, 431, 447.2, 460, 466.7 479.2, 494.8, 511.3, 528, 535.7 567.9, 571.7, 590.3, 630, 639.2 656.2, 677.6, 705.8, 733.7 749.6, 759.7, 800, 811.7, 833.3 842.1, 860.4, 894.4, 902.2 931.7, 964.7, 994.3, 1005, 1027 1036, 1069, 1112, 1136, 1158, 1199 1236, 1276, 1304, 1329, 1382, 1523 1556, 1586, 1755, 1892, 1933, 1975 2014, 2403, 2455, 3051, 3792, 4713	46.5Kgf-cm	139.5Kgf-cm	75%	53.7

表中*指速比数值。 * - Reduction ratio

①——根据受力，行星轮可选用塑料。 Planet gears can be plastic according to torque.

②——高速时齿轮箱长度非标。 Gearbox length is nonstandard at high speed.

Dia 30mm metal planetary gear JPM30



JPM30

Weight: N/A (approx.)

Tags: Planetary Gearbox motor

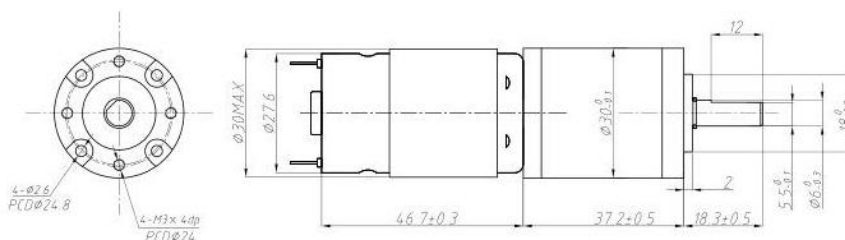

產品規格/ Product Specifications

外殼材質 Housing material	輸出軸承型式 Bearing at output	徑向負荷 Radial load (10mm from flange)	軸向負荷 Shaft axial load	主軸最大承受壓入力 Shaft press fit force, max.	徑向間隙 Radial play of shaft	軸向間隙 Thrust play of shaft	背隙 (無負荷時) Backlash, at no-load
金屬 Metal	含油軸承 Sleeve bearings	≤ 3 kgf	≤ 2.5 kgf	≤ 10 kgf	≤ 0.08 mm	≤ 0.3 mm	$\leq 2.5'$
金屬 Metal	滾珠軸承 Ball bearings	≤ 3.5 kgf	≤ 2.5 kgf	≤ 10 kgf	≤ 0.05 mm	≤ 0.3 mm	$\leq 2.5'$

馬達齒輪型式/ Pinion Specifications

模數 Module	齒數 No. of teeth	壓力角 Pressure angle	孔徑 (mm) Hole diameter	減速比 Reduction ratio
0.5	11	20°	$\phi 2.28, \phi 2.48, \phi 2.98$	1/5, 1/19, 1/27, 1/71, 1/100, 1/139, 1/264, 1/516, 1/721
0.5	17	20°	$\phi 2.28, \phi 2.48, \phi 2.98$	1/4, 1/14, 1/51, 1/189
0.5	8	20°	$\phi 2.28$	1/35, 1/939

標準減速比型式/ Gearboxes Specifications

減速比 Reduction ratio	1/4	1/5	1/14	1/19	1/27	1/35	1/51	1/71	1/100	1/139	1/189	1/264	1/516	1/721	1/939
定格容許扭力 (kgf-cm Max.) Rated tolerance torque	2	2	3	3	4	4	6	6	8	8	10	10	10	10	10
瞬間容許扭力 (kgf-cm) Max momentary tolerance torque	6	6	9	9	12	12	18	18	24	24	30	30	30	30	30
效率 Efficiency	80%	80%	70%	70%	70%	70%	60%	60%	60%	60%	50%	50%	50%	50%	50%
長度 Length (L)	23.6	23.6	30	30	30	30	36.4	36.4	36.4	36.4	42.8	42.8	42.8	42.8	42.8
重量 (含油軸承) Weight (g) / Sleeve bearings	79	79	92	92	92	92	107	107	107	107	122	122	122	122	122
重量 (滾珠軸承) Weight (g) / Ball bearings	78	78	91	91	91	91	106	106	106	106	121	121	121	121	121

- 使用相對濕度：20%~85%RH
Operating relative humidity
- 使用溫度範圍：-10°C~+60°C
Operating temperature range

Dia 28mm metal planetary gear JPM28



JPM28

Weight: N/A (approx.)

Tags: Planetary Gearbox motor

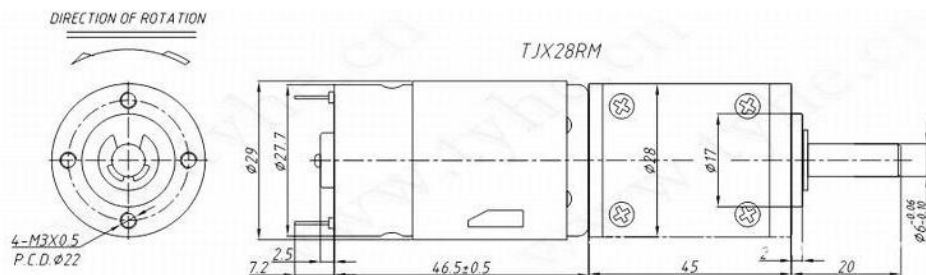

额定电压 Rated Voltage	减速比 Reduction Ratio	1/3.7	1/5.2	1/13.7	1/19.2	1/27	1/51	1/71	1/100	1/139	1/187	1/262	1/368	1/514	1/720	1/970	1/1900
	齿轮箱长度(mm) Gearbox Length	30			38.6			45			52			59			
12V	额定力矩(kg.cm) Rated Torque	0.2	0.2	0.5	0.8	1.1	1.8	2.5	3.6	5.0	5.9	8.3	11.6	16.2	22.7	27.8	100.0
	额定转速(rpm) Rated Speed	2100	1491.2	567.2	404.7	287.8	152.4	108.4	77.7	55.9	41.6	29.7	21.1	15.1	10.8	8.0	4.1
	堵转力矩(kg.cm) Stall Torque	1.2	1.7	4.1	5.8	8.1	14.0	19.5	27.5	38.2	45.3	63.5	89.1	124.5	300.0	300.0	300.0
24V	额定力矩(kg.cm) Rated Torque	0.1	0.2	0.5	0.6	0.8	1.5	2.1	2.3	3.1	4.2	5.9	8.3	11.6	16.2	21.8	100.0
	额定转速(rpm) Rated Speed	1905	1355.8	514.6	367.2	261.1	138.2	99.3	70.5	50.7	37.7	26.9	19.2	13.7	9.8	7.3	3.7
	堵转力矩(kg.cm) Stall Torque	1.2	1.7	4.5	5.4	7.6	14.3	19.9	21.1	29.3	39.4	55.2	77.5	108.2	300.0	300.0	300.0

Dia 24mm metal planetary gear JPM24



JPM24

Weight: N/A (approx.)

Tags: Planetary Gearbox motor

Appearance of size

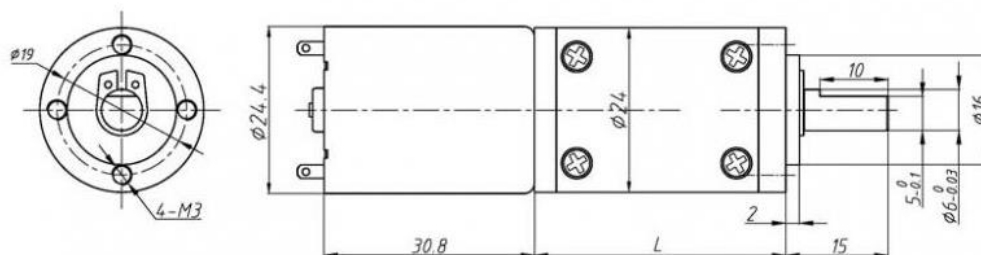

额定电压 Rated Voltage	减速比 Reduction Ratio	1/3.7	1/5.2	1/13.7	1/19.2	1/27	1/51	1/71	1/100	1/139	1/187	1/282	1/388	1/514	1/720	1/970	1/1900
	齿轮箱长度(mm) Gearbox Length	30		38.6			45			52			59				
12V	额定力矩(kg.cm) Rated Torque	0.03	0.04	0.08	0.12	0.16	0.31	0.43	0.60	0.83	1.12	1.57	2.21	3.08	6.00	6.00	6.00
	额定转速(rpm) Rated Speed	1595	1134.6	430.7	307.3	218.5	115.7	83.1	59.0	42.4	31.6	22.5	16.0	11.5	6.2	6.1	3.1
	堵转力矩(kg.cm) Stall Torque	0.3	0.4	0.8	1.1	1.6	3.0	4.2	5.9	8.1	10.9	15.3	21.5	24.0	24.0	24.0	24.0
24V	额定力矩(kg.cm) Rated Torque	0.07	0.10	0.21	0.29	0.41	0.77	1.07	1.50	2.09	2.81	3.93	5.52	7.71	10.80	14.55	6.00
	额定转速(rpm) Rated Speed	2027	1442.3	547.4	390.6	277.8	147.1	105.6	75.0	54.0	40.1	28.6	20.4	14.6	10.4	7.7	3.9
	堵转力矩(kg.cm) Stall Torque	0.4	0.6	1.1	1.6	2.2	4.1	5.8	8.1	11.3	15.1	21.2	29.8	41.6	15.0	15.0	15.0

Dia 22mm metal planetary gear JPM22



JPM22

Weight: N/A (approx.)

Tags: Planetary Gearbox motor

DIRECTION OF ROTATION

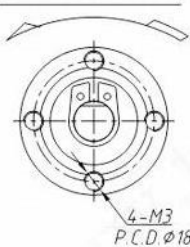

TJX22RC

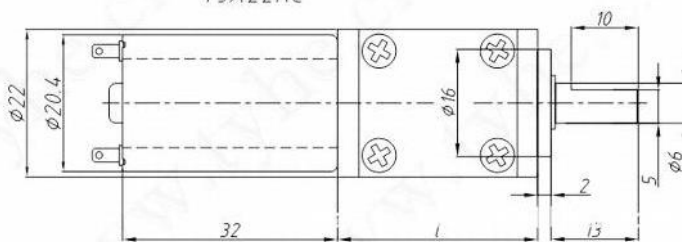

额定电压 Rated Voltage	减速比 Reduction Ratio	1/3.7	1/5.2	1/13.7	1/19.2	1/27	1/51	1/71	1/100	1/139	1/187	1/262	1/368	1/514	1/720	1/970	1/1900
齿轮箱长度(mm) Gearbox Length		30		38.8			43				49.5				58		
12V	额定转矩 (kg.cm) Rated Torque	0.04	0.06	0.12	0.17	0.24	0.45	0.63	0.89	1.24	1.67	2.33	3.28	4.58	6.00	6.00	6.00
	额定转速 (rpm) Rated Speed	1257	894.2	339.4	242.2	172.2	91.2	65.5	46.5	33.5	24.9	17.7	12.6	9.0	6.5	4.8	2.4
	堵转转矩 (kg.cm) Stall Torque	0.1	0.2	0.4	0.5	0.8	1.4	2.0	2.8	3.9	5.3	7.4	10.4	21.0	21.0	21.0	24.0
24V	额定转矩 (kg.cm) Rated Torque	0.05	0.07	0.13	0.18	0.26	0.49	0.68	0.96	1.33	1.80	2.52	3.53	4.93	6.91	8.31	6.00
	额定转速 (rpm) Rated Speed	2089	1471.9	558.7	398.6	283.5	150.1	107.8	76.5	55.1	40.9	29.2	20.8	14.9	10.6	7.9	4.0
	堵转转矩 (kg.cm) Stall Torque	0.2	0.3	0.6	0.9	1.2	2.3	3.2	4.4	6.2	8.3	11.6	16.4	22.9	15.0	15.0	15.0

Dia 16mm Planetary Gearbox+motor

JPM-16R

Weight:N/A



Typical Application

Precision control fields like medical instrument, industrial control and so on.

Tags: Planetary Gearbox motor

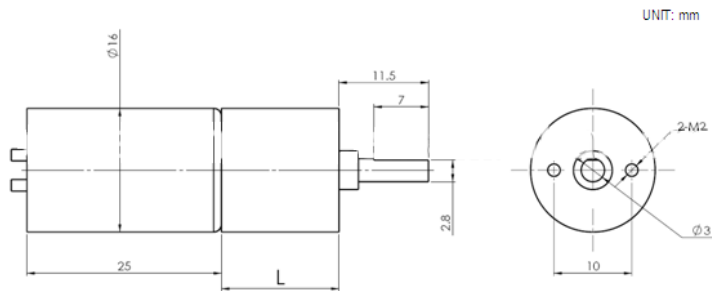

Motor Characteristics			
		JPM-1627R	
1	Voltage	V	12.0
2	Terminal resistance	Ω	71.3
3	No-load speed	rpm	8500
4	No-load current	mA	5
5	Stall torque	mNm	0.0
6	Stall current	mA	168
7	Nominal torque	mNm	1.00
8	Nominal speed	rpm	4521
9	Nominal current	mA	81

Gearbox Characteristics					
Reduction ratio	Max. rated tuorque	Max. momentary torque	Length(L)		
	mNm	mNm	mm		
1	4	80	240	15.05	
2	14, 16, 19, 29	120	360	18.7	
3	53, 62, 72, 84, 104, 128, 157	160	480	22.35	
4	231, 316, 370, 455, 561, 690	200	600	26	
5	1014, 1621, 1996, 3027	240	720	29.65	

Customization

Lead wires length, Shaft length, Special coils, Encoder

Dia 16mm metal planetary gear JPM16



JPM16

Weight: N/A (approx.)

Tags: planetary gear

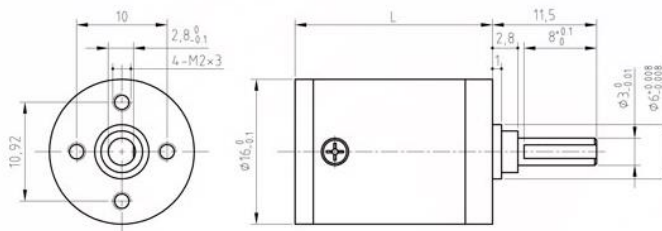

外壳材料 Housing material	金属 steel
齿轮材料 Gearwhddl material	金属 steel ①
输出轴承型式 Bearing at output	滚动轴承 Ball bearings
径向负载 Radial load (10mm from flange)	≤1.6 Kgf
轴向负载 shaft axial load	≤0.5 Kgf
径向间隙 Radial play of shaft	≤0.04mm
轴向间隙 Thrust play of shaft	≤0.4mm
背隙 (无负载时) Backlash,at no-load	≤2°
连续运行时最高允许输入转速 Max permissible input speed at continuous working	≤42000rpm ②
工作温度范围 Operating temperature range	-30~100°C

减速比(部分) Reduction ratio (part)	额定允许负载 rated tolerance torque	瞬间允许负载 Max momentary tolerance torque	效率 Efficiency	L (mm)
3.75, 4.4, 5.4, 6.5	4.2Kgf-cm	12.6Kgf-cm	93%	17.9
14.5, 16.4, 19.2, 20.3, 23.7, 24.4, 28.5, 29.2, 35.1, 42.3	6.0Kgf-cm	18.0Kgf-cm	86%	21.8
48.2, 54.5, 61.7, 67.1, 75.9, 80.8, 88.8, 94.5, 103.8, 106.9, 109.3, 125, 131, 154, 185.3	7.5Kgf-cm	22.5Kgf-cm	80%	25.7
204.4, 228, 251.8, 274.6, 294.4, 303, 313.3, 333, 342.7	9.0Kgf-cm	27Kgf-cm	75%	29.6
354.4, 369.6, 389.3, 400.8, 455.2, 468.6, 493.6, 547.9, 560.6, 577.1, 674.8, 690.4	9.0Kgf-cm	27Kgf-cm	70%	33.5
738, 850.3, 944.2, 1023.5, 1136.6, 1175, 1232, 1328.9, 1447.2, 1483, 1502.9, 1636.7, 1692, 1757, 1785, 1851, 1914, 1996, 2055, 2164, 2402, 2458, 2530, 2959, 3027, 3644, 3728, 4488, 4592, 5527, 6653, 8008, 9639, 11600	9.0Kgf-cm	27Kgf-cm	70%	33.5

表中*指速比数值。 * - Reduction ratio

①—— 根据受力, 行星轮可选用塑料。 Planet gears can be plastic according to torque.

②—— 高转速时齿轮箱长度非标。 Gearbox length is nonstandard at high speed.

Dia 15mm Planetary Gearbox motor



JPM-15A

Weight:N/A

Typical Application

Precision control fields like medical instrument, industrial control and so on.

Tags: Planetary Gearbox motor

UNIT: mm

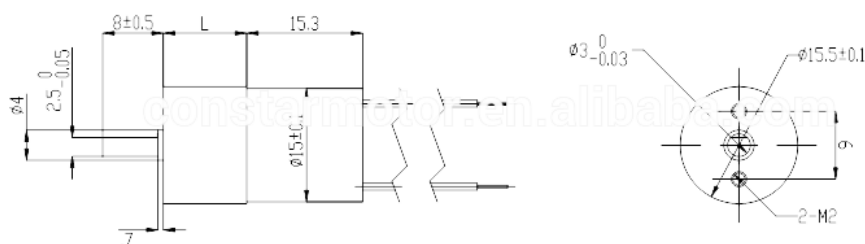

Motor Characteristics			
			JPM-1515A
1	Voltage	V	18.0
2	Terminal resistance	Ω	30.5
3	No-load speed	rpm	22000
4	No-load current	mA	30
5	Stall torque	mNm	4.15
6	Stall current	mA	590
7	Nominal torque	mNm	1.80
8	Nominal speed	rpm	12467
9	Nominal current	mA	273
10	Max. output power	W	2.39
11	Max. efficiency	%	60

Gearbox Characteristics				
	Reduction ratio	Max. rated tuorque	Max. momentary torque	Length(L)
		mNm	mNm	mm
1	3, 7, 10	20	60	11
2	16, 17, 20, 30, 35	30	90	11
3	50, 63	40	120	11
4	70, 86	50	150	11
5	115, 150	60	180	11
6	210, 250	70	200	11
7	360	80	220	11

Customization

Lead wires length, Shaft length, Special coils, Encoder

Dia 12mm Planetary Gearbox motor



JPM-12B

Weight:N/A

Typical Application

Audio and visual products, high-end toys, personal health care products and security equipment

Tags: Planetary Gearbox motor

Series	Dimension (mm)	Voltage (V)	No-load Speed (rpm)	No-load Current (mA)	Load Torque (mNm)	Load Speed (rpm)	Load Current (mA)	Max Torque (mNm)	Reduction Ratio	
JPM-1219R	φ12*40.0	6	225	40	14.7	204	150	156.8	1/64	

Customization

Lead wires length, shaft length, special coils, gearheads, Encoder

Dia 10mm Planetary Gearbox motor

JPM-10R

Weight: N/A



Typical Application

Audio and visual products, high-end toys, personal health care products and security equipment

Tags: Planetary Gearbox motor

UNIT: mm

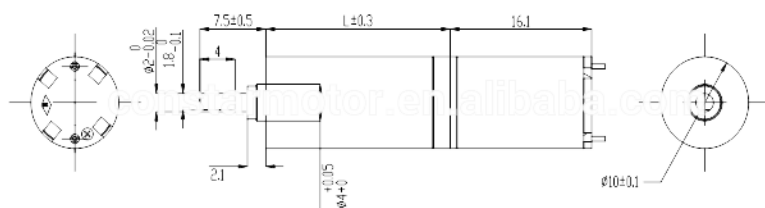

Motor Characteristics			
			JPM-1016R
1	Voltage	V	7.5
2	Terminal resistance	Ω	56.0
3	No-load speed	rpm	10900
4	No-load current	mA	7
5	Stall torque	mNm	0.8
6	Stall current	mA	134
7	Nominal torque	mNm	0.40
8	Nominal speed	rpm	5384
9	Nominal current	mA	71
10	Max. output power	W	0.23
11	Max. efficiency	%	60
Gearbox Characteristics			
	Max. rated tuorque	Max. momentary torque	Length(L)
	mNm	mNm	mm
1	5	15	11.7
2	10	30	14.8
3	30	90	17.9
4	40	120	21
5	50	150	24.1
6	60	180	27.2

Customization

Lead wires length, shaft length, special coils, gearheads.

Dia 6mm Planetary Gearbox motor

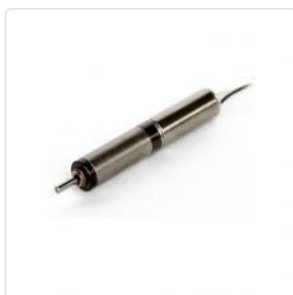

JPM-06R

Weight:N/A

Typical Application

Audio and visual products, high-end toys, personal health care products and security equipment

Tags: Planetary Gearbox motor

Series	Dimension (mm)	Voltage (V)	No-load Speed (rpm)	No-load Current (mA)	Load Torque (mNm)	Load Speed (rpm)	Load Current (mA)	Max Torque (mNm)	Reduction Ratio
JPM-06R	φ6*32	3	319	43	5	186	145	11.8	1/50.8

Customization

Lead wires length, shaft length, special coils, gearheads

10mm Miniature Plastic Planetary DC Gear Motor



JM-10AM20

Weight: ~9.5g(approx.)

Typical Application

Robot
 Electric L
 Video/Ca
 Beauty Pr
 Electric lock

Key Features

-10mm closed plastic Gearbox
 -Metal Brush DC Motor
 -Plastic Planetary Gears

-Reversibl
 -RoHS Co

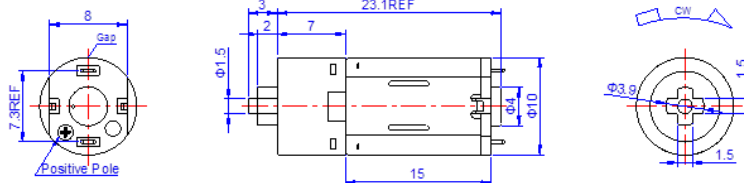

Gear box length L (mm)	General Reduction Ratios
11	171/1

Ratio	Model No.	Voltage		No Load		On Load		
		Operating Range	Nominal Voltage	Current	Speed	Current	Torque	Speed
171/1	JM-10AM20-171-05100	2.0-5.0	5	0.04	100	0.108	0.17	73
171/1	JM-10AM20-171-0575	2.0-5.0	5	0.038	75	0.09	0.17	57
171/1	JM-10AM20-171-06200	2.0-6.0	6	0.063	200	0.272	0.248	162

Remarks

1. All values approximate.
2. Customized electric performance on request by using suitable dc motor windings.
 Available with required accessories after evaluation.

10mm Miniature Plastic Planetary DC Gear Motor

JM-10A1012

Weight: ~9.5g(approx.)



Typical Application

Robot
Electric L
Video/Ca
Beauty Pr

Key Features

-10mm closed plastic Gearbox
-Metal Brush DC Motor
-Plastic Planetary Gears
-Reversible

-RoHS Compliant

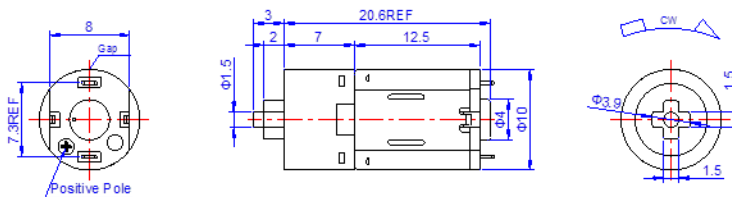

Gear box length L (mm)	General Reduction Ratios
11	171/1

Ratio	Model No.	Voltage		No Load		On Load		
		Operating Range	Nominal Voltage	Current	Speed	Current	Torque	Speed
171/1	JM-10A1012 -171-01.5140	1.0-2.0	1.5	0.15	140	0.51	0.18	108
171/1	JM-10A1012 -171-01.538	1.0-2.0	1.5	0.034	38	0.073	0.062	26
171/1	JM-10A1012 -171-03120	2.0-3.5	3	0.056	120	0.176	0.129	91
171/1	JM-10A1012 -171-0396	2.0-3.5	3	0.058	96	0.146	0.136	68
171/1	JM-10A1012-171-05112	2.0-5.0	5	0.032	112	0.085	0.099	81

Remarks

1. All values approximate.
2. Customized electric performance on request by using suitable dc motor windings.
3. Available with required accessories after evaluation.